

**USER GUIDE AND INSTALLATION MANUAL
FLUSH-FITTING OR INTEGRATED
WEATHERPROOF « HANDS FREE » TELEPHONE
FOR STERILE AREAS**

TLS 250 S TYPE

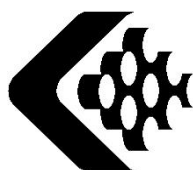
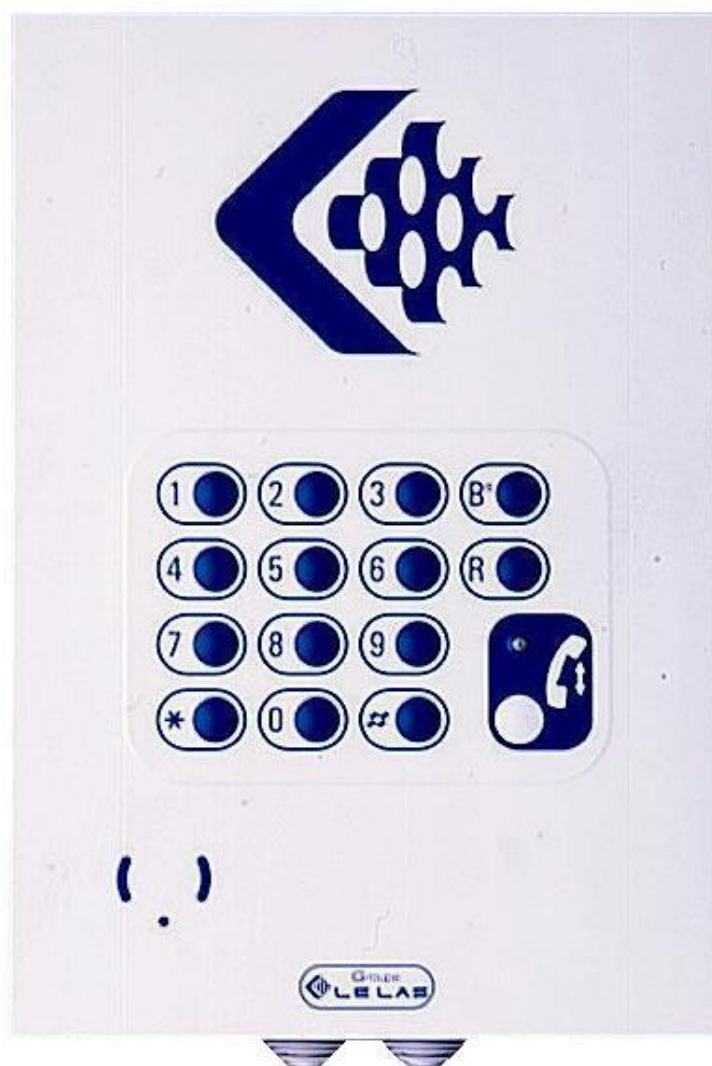

Groupe LE LAS
COMMUNICATING IN SAFETY

CONTENTS

1. PRESENTATION	3
1.1 TELEPHONE TYPES	3
1.2 GENERAL CHARACTERISTICS	4
1.3 CONTENTS OF THE PACKAGE	5
1.4 GENERALE DESCRIPTION OF TLS TELEPHONES	5
1.5 TECHNICAL CHARACTERISTICS OF TLS TELEPHONE	6 - 7
1.6 DESCRIPTION OF TLS 250 S1 CL TYPE TELEPHONE	8
1.7 DESCRIPTION OF TLS 250 S1 CLD TYPE TELEPHONE	9
1.8 DESCRIPTION OF TLS 250 S1 CLS TYPE TELEPHONE	10
1.9 DESCRIPTION OF KEYPAD	11
2. INSTALLATION OF TELEPHONES	12
2.1 INSTALLATION OF TLS 250 S1 CL	12
2.2 TLS 250 S1 CL MOUNTING INSTRUCTIONS.....	13
2.3 INSTALLATION OF TLS 250 S1 CLD	14
2.4 TLS 250S1 CLD MOUNTING INSTRUCTION.....	15
2.5 INSTALLATION OF TLS 250 S1 CLS	16
2.6 TLS 250S1 CLS MOUNTING INSTRUCTION	17
3. LAYOUT OF THE TELEPHONE CARD	18
3.1 FUNCTIONS AND JUMPER SETTINGS	18
4. CONNECTION OF THE TELEPHONE SET	19
4.1 OPENING THE TELEPHONE SET	19
4.2 CONNECTION OF THE TELEPHONE LINE.....	19
5. USAGE OF THE TELEPHONE WITH FULL KEYPAD	20
6. OPTIONS	1
6.1 RELAY BOARD - DOOR ENTRY / PUBLIC ADDRESS WK026CRG	23
6.2 AMPLIFIER CARD WK087CRA.....	24
7. PROGRAMMING	25
8. OPERATIONAL COMMAND CODES	33
9. MAINTENANCE	34
10. IN THE EVENT OF A PROBLEM	12
11. SPARE PARTS LIST	34

1. PRESENTATION

1.1 TELEPHONE TYPES

FLUSH FITTING WEATHERPROOF HANDS FREE TELEPHONE WITH KEYBOARD FOR CLEAN ROOM TLS 250 S1 CL

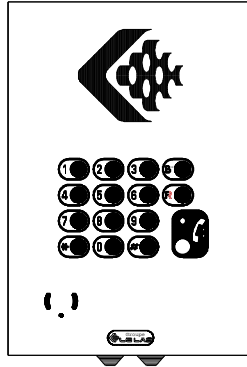

(See page 8)

INTEGRATED WEATHERPROOF HANDS FREE TELEPHONE WITH KEYBOARD FOR CLEAN ROOM TLS 250 S1 CLD

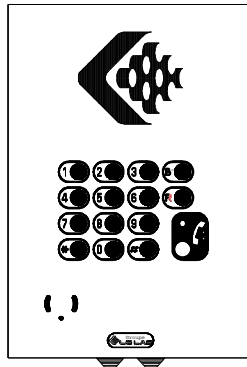

(See page 9)

FLUSH MOUNTED WEATHERPROOF HANDS FREE TELEPHONE WITH KEYBOARD FOR CLEAN ROOM TLS 250 S1 CLS

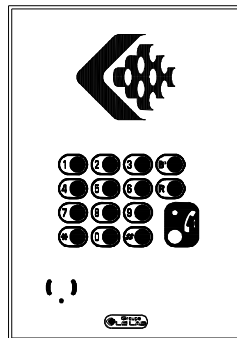

(See page 10)

1.2 GENERAL CHARACTERISTICS

EQUIPMENT FOR STERILE AREAS HANDS FREE WEATHERPROOF TELEPHONES SERIES TLS 250 S

DEGREE OF PROTECTION

IP65 (ON FACE-PLATE)

NOTES

THESE PRODUCTS CONFORM TO IP65 WEATHERPROOFING CLASSIFICATION

THE GUARANTEE IS VALID ONLY WHERE PRODUCTS ARE INSTALLED AND OPERATED STRICTLY IN ACCORDANCE WITH THE INSTRUCTIONS DESCRIBED IN THIS MANUAL.

NO GUARANTEE CAN BE INVOKED IF DETERIORATION RESULTS FROM AN EXTERNAL SOURCE OR FROM LACK OF ADHERENCE TO INSTRUCTIONS FOR USE.

IN THE DESIRE FOR CONTINUAL IMPROVEMENT, THE INFORMATION CONTAINED IN THIS DOCUMENT AND THE CHARACTERISTICS OF THE EQUIPMENT MAY BE SUBJECT TO MODIFICATION WITHOUT PRIOR NOTICE

EUROPÉAN STANDARDS

UNITS BEARING THE CODE “ CE ” CONFORM TO EMC DIRECTIVE EMC (89/336/EEC) AND THE DIRECTIVE RELATING TO LOW VOLTAGE (73/23/EEC) FORMULATED BY THE EUROPEAN COMMUNITY.

**UK BAPT APPROVAL N° 504612
AND IN FRANCE
ART N° 98656P DU 8 JUILLET 1998**

1.3 CONTENTS OF THE PACKAGE

The equipment you have received comprises:

- A telephone set
- A user manual
- A kit for assembly on panel thickness 13mm Réf: GM250S1E13
NOTE : Kit available for thickness of panel 20 and 26mm

1.4 GENERAL DESCRIPTION OF TLS TELEPHONES

The « Hands free » weatherproof telephones are Automatic Central Battery (ACB) telephones without handset which can be used in centrally powered networks or installations withing the voltage limits permitted by our equipment (see technical characteristics).

These telephones are equipped with:

- A weatherproof loudspeaker
- A weatherproof « Electret » type microphone
- An electronic circuit card
- An on-line LED
- A keypad with function keys

FEATURES

- Pulse/Tone dialling.
- Automatic clear-down capability.
- Automatic answering capability or answering after a programmable number of rings.
- Programming of stored numbers locally or via telephone line from any DTMF telephone.
- Chained numbers if the called number is busy or does not answer after a programmable time.
- Modification of settings via telephone line from any DTMF telephone or via a maintenance station, for example:
 - Ringing type
 - Ringing volume
 - Loudspeaker volume
 - Dialling type
 - Automatic answer etc...

1.5 TECHNICAL CHARACTERISTICS OF TLS TELEPHONE

IMPORTANT

THESE MICROPROCESSOR BASED PRODUCTS, WHEN CONNECTED TO THE TELEPHONE LINE, CARRY OUT AN AUTO-TEST BY TRANSMITTING AUDIBLE SIGNALS.

THEY ARE EQUIPPED WITH MANY PROGRAMMABLE FUNCTIONS AND ARE FACTORY CONFIGURED FOR NORMAL USE.

BEFORE INSTALLATION, READ THIS MANUAL CAREFULLY TO BE SURE THE FACTORY SETTING SUITS THE DESIRED USE.

The « Hands free » telephones operate without any modification to PSTN circuits. For perfect operation on a PABX, it is necessary to ensure that the following characteristics conform to those of your switch.

In the event of incompatibility, software modifications can be carried out on request. Contact the supplier for more information.

TECHNICAL CHARACTERISTICS

- Ringing call voltage > 35 V RMS 25Hz or 50Hz
- Current in the telephone (off-hook position) 35mA (20mA minimum)
- Voltage at terminals (on-hook position) 48V (24V minimum)
- Dialling system DTMF or Pulse
- Dialling tone Continuous tone
Frequency: 270 to 540Hz Detection time 2 sec.minimum
- Busy tone
Frequency: 300 to 500 Hz
Beep/pause sequence for more than 10 seconds. Detection time 4-10 sec
Beep: 100 to 600 ms
Pause: 100 to 600 ms
- Distance ringing tone
Frequency: 350 à 500Hz
Beep/pause sequence until far-end off-hook
Beep: 0.2sec. to 1.6 sec.
Beep + pause sequence < 6 sec.
- End of conversation sequenced tone
Frequency: 300 to 500 Hz
Beep/pause sequence for more than 10 seconds. Detection time 4-10 sec
Beep: 100 to 600 ms
- End of conversation continuous tone
Frequency: 300 to 500 Hz or 760 to 840 Hz
Tone sequence for more than 10 seconds Detection time 6-10 sec.
- Call voltage transmitted by the switch
Frequency : 50Hz or 25Hz
Ringing duration : 1.5s ± 0.5s
Pause duration : 3s ± 2s

1.6 DESCRIPTION OF FLUSHFITTING TELEPHONE TYPE TLS250S1 CL

ACB-type flushfitting telephone set with weatherproof faceplate (IP65) comprising a painted steel-plate backing-case and a stainless faceplate with a self-adhesive polyester plaque with integrated keypad.

The unit is closed by clipping the faceplate on to the backing-case.

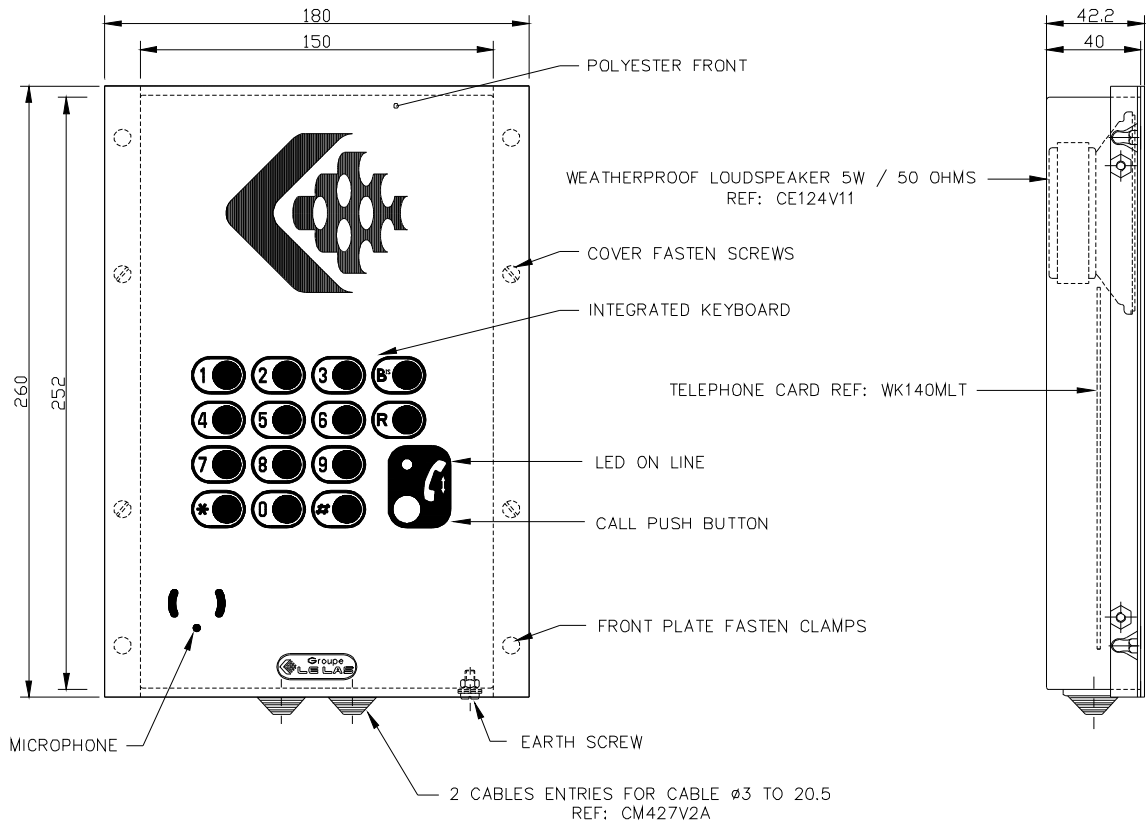

1.7 DESCRIPTION OF INTEGRATED TELEPHONE TYPE TLS250S1 CLD

ACB-type flushfitting telephone set with weatherproof faceplate (IP65) comprising a painted steel-plate backing-case and a stainless faceplate with a self-adhesive polyester plaque with integrated keypad (to be stuck on to the panel).

The unit is closed by clipping the faceplate on to the backing-case.

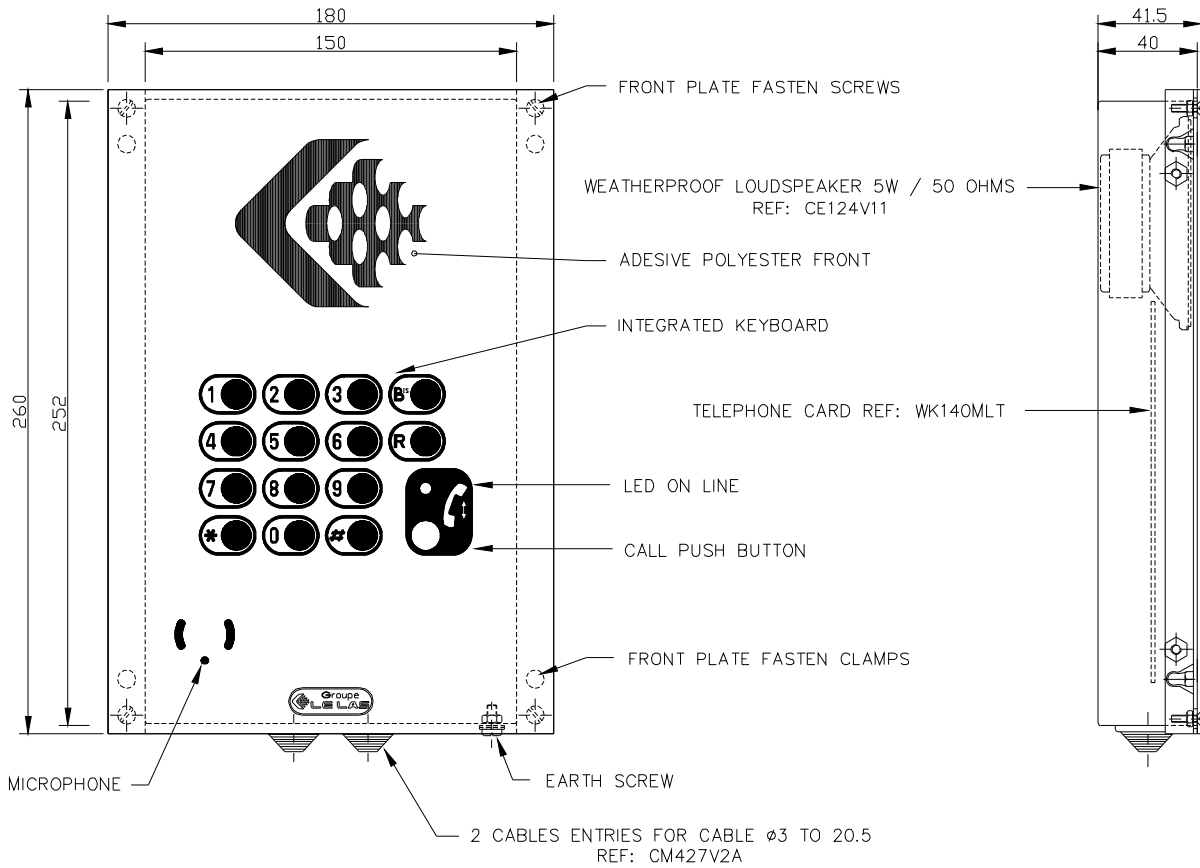

1.8 DESCRIPTION OF FLUSH MOUNTING TELEPHONE TYPE TLS250S1 CLS

ACB type flush mounted telephone set with weatherproof front case (IP65) and a stainless steel. Face plate with an integrated self adhesive key board. The face plate is fastened by three wall fixed screws.

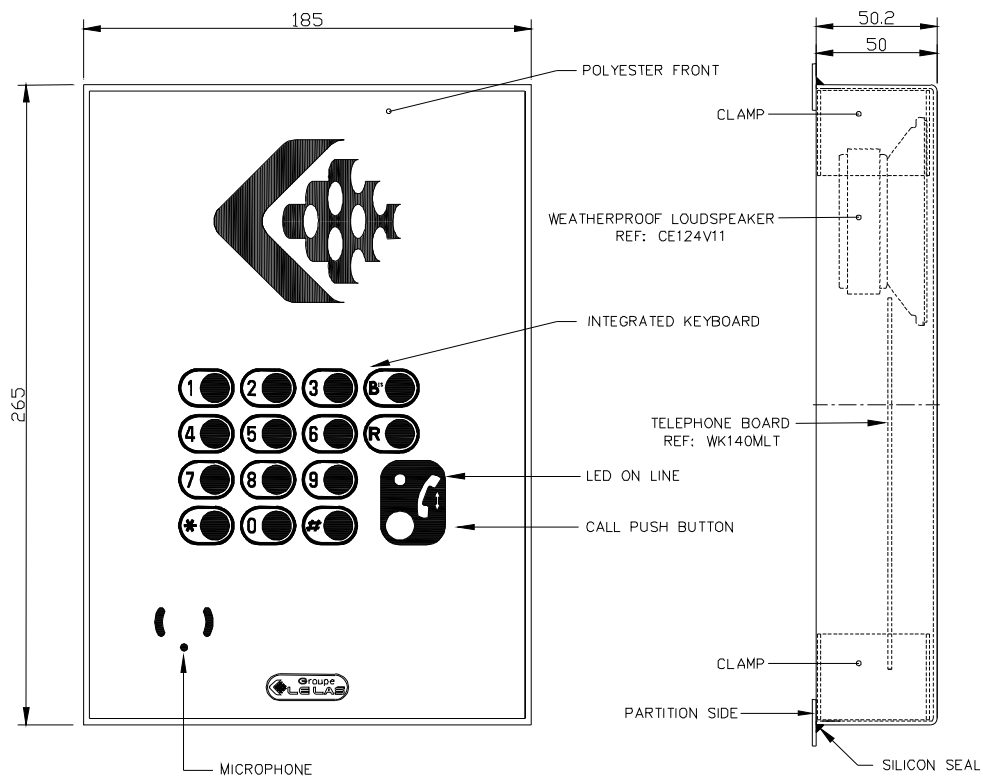

WEATHERTIGHTING
(MADE BY CUSTOMER AFTER INSTALLATION)

1.9 DESCRIPTION OF KEYPAD

15 button weatherproof keypad with on-line reassurance indicator.

Legend and layout are identical for both telephone sets.

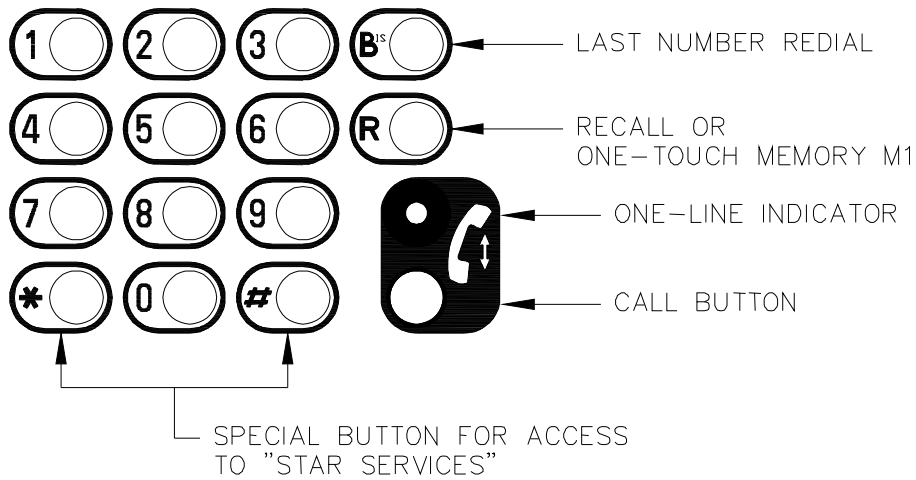

NOTE : Programming 10 direct memory access for keys 0 to 9 is allowed see chapter « autodial numbers M0 to M9 » page 26.

- Remotely checked phones : 8 memories M1 to M8 available by pushing keys 1 to 8 without pushing call button.
- Phones without remotely checked facility : 10 memories M0 to M9 by pushing keys 0 to 9 without pushing call button.

NOTE

THE RECALL BUTTON  HAS A THREE FUNCTIONS

ACCORDING TO PROGRAMMING:
FLASHING OR ONE-TOUCH MÉMOIRE M1 OR MUTING MICROPHONE

Each function is described separately on page 20.

2. INSTALLATION OF THE TELEPHONES

2.1 INSTALLATION OF TLS 250 S1 CL

CUT-OUT PLAN FOR INSERTION INTO A PANEL

Cut out the panel according to measurements below.

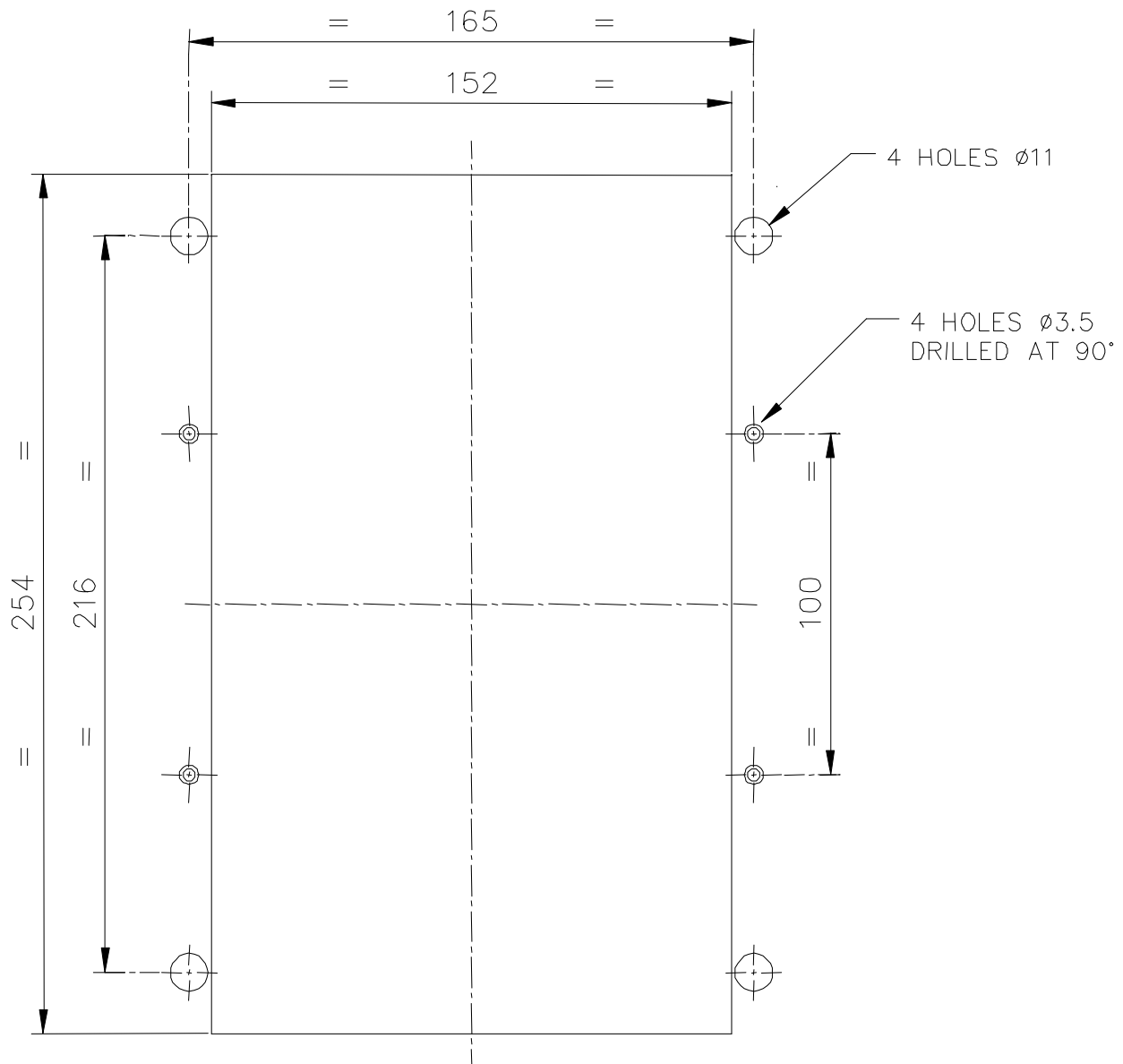

For assembly on panel thickness of 13mm, to use the kit provided with the station.
This Kit including/understanding: 4 milled spacers and 4 screws F90M3/20.

ASSEMBLY:

- to unscrew the 4 pins located has the back of the front face and screwed on the spacers.
- To screw these spacers in the place of the pins.
- To use the milled screws provided with the kit to fix the squares locates B.

NOTE : For other thickness please ask us.

2.2 TLS 250 S1 CL MOUNTING INSTRUCTIONS

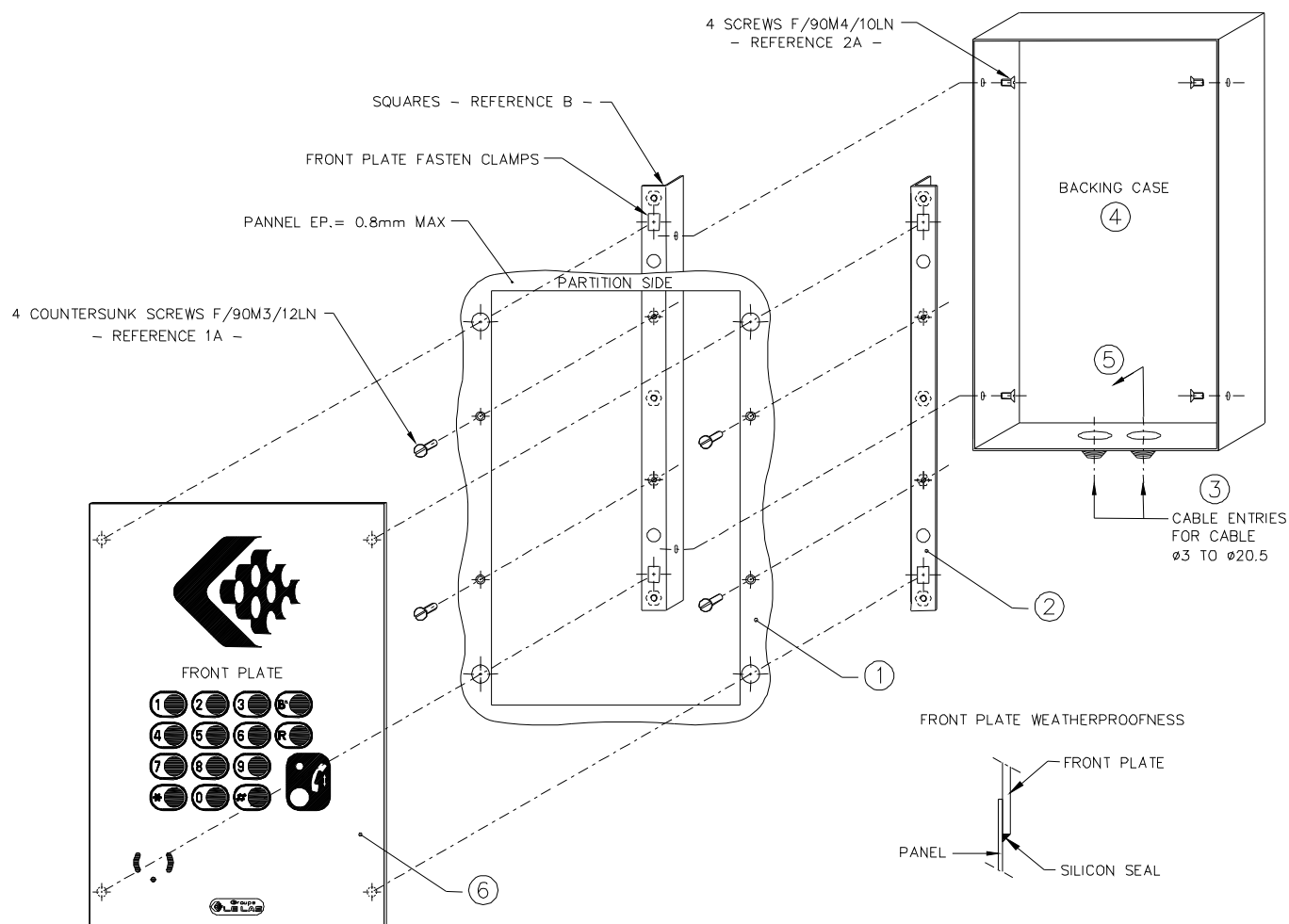

For assembly on panel thickness of 13mm, to use the kit provided with the station.

- 1 - Cut out the panel according to measurements below (PARTITION SIDE 0.8mm MAX)
- 2 - Position the squares (reference B) behind the panel.
Fasten the screws (reference 1A) matching the holes in the sides with those in the panel.
- 3 - Pass the cable through the cable entry leaving sufficient cable length for connection.
- 4 - Position the backing-case between the squares, then fasten the 4 screws (reference 2A) via the Interior of the backing-case.
- 5 - Connect the line to the circuit-board terminals (see page, 19) then fasten the telephone.
- 6 - Weatherproof the face plate on the panel with a silicon sealing joint (see detail above).

2.3 INSTALLATION OF TLS 250 S1 CLD

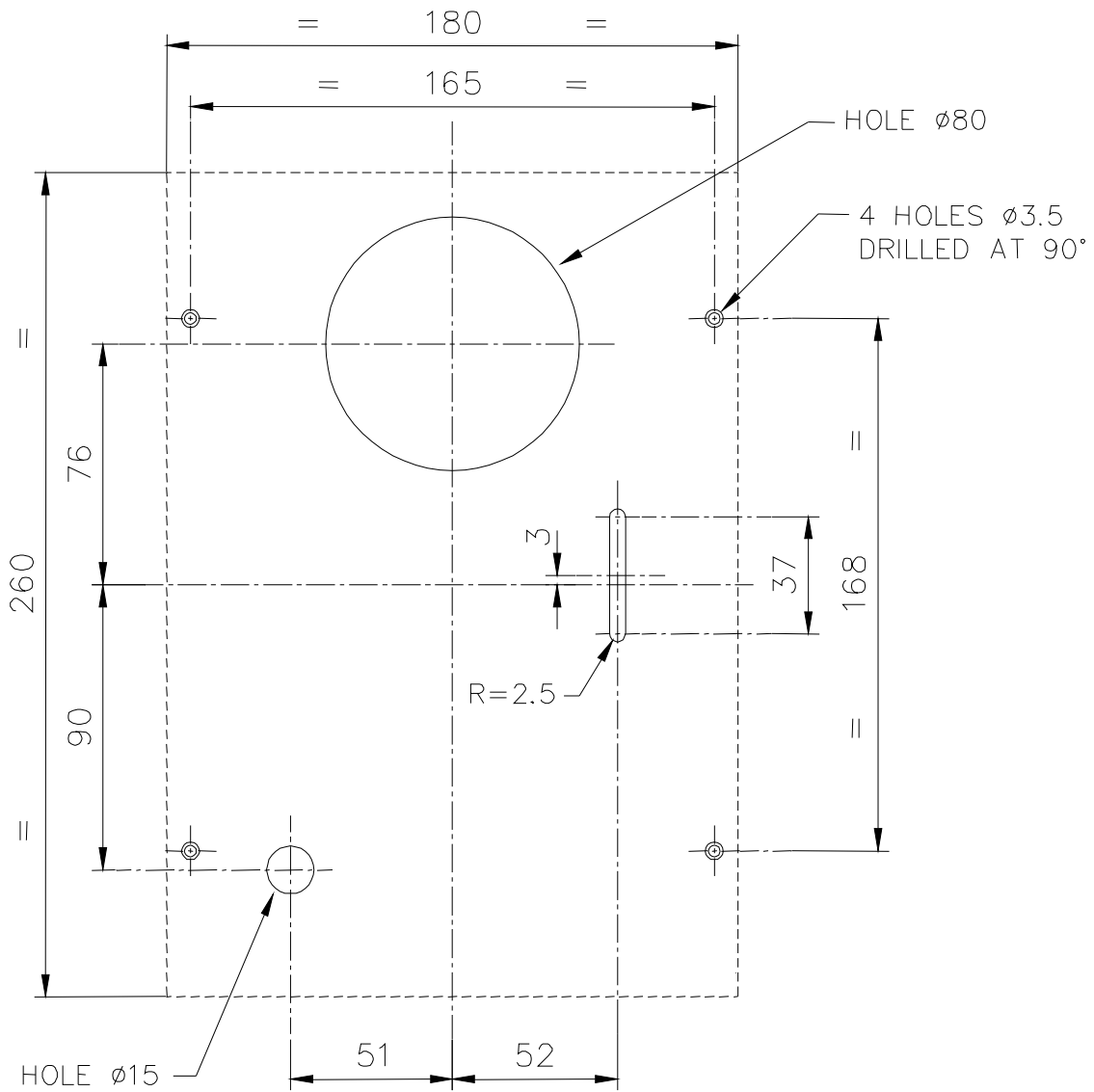

CUT-OUT PLAN FOR INSERTION INTO A PANEL

Cut out the panel according to the values above

2.4 TLS 250 S1 CLD MOUNTING INSTRUCTIONS

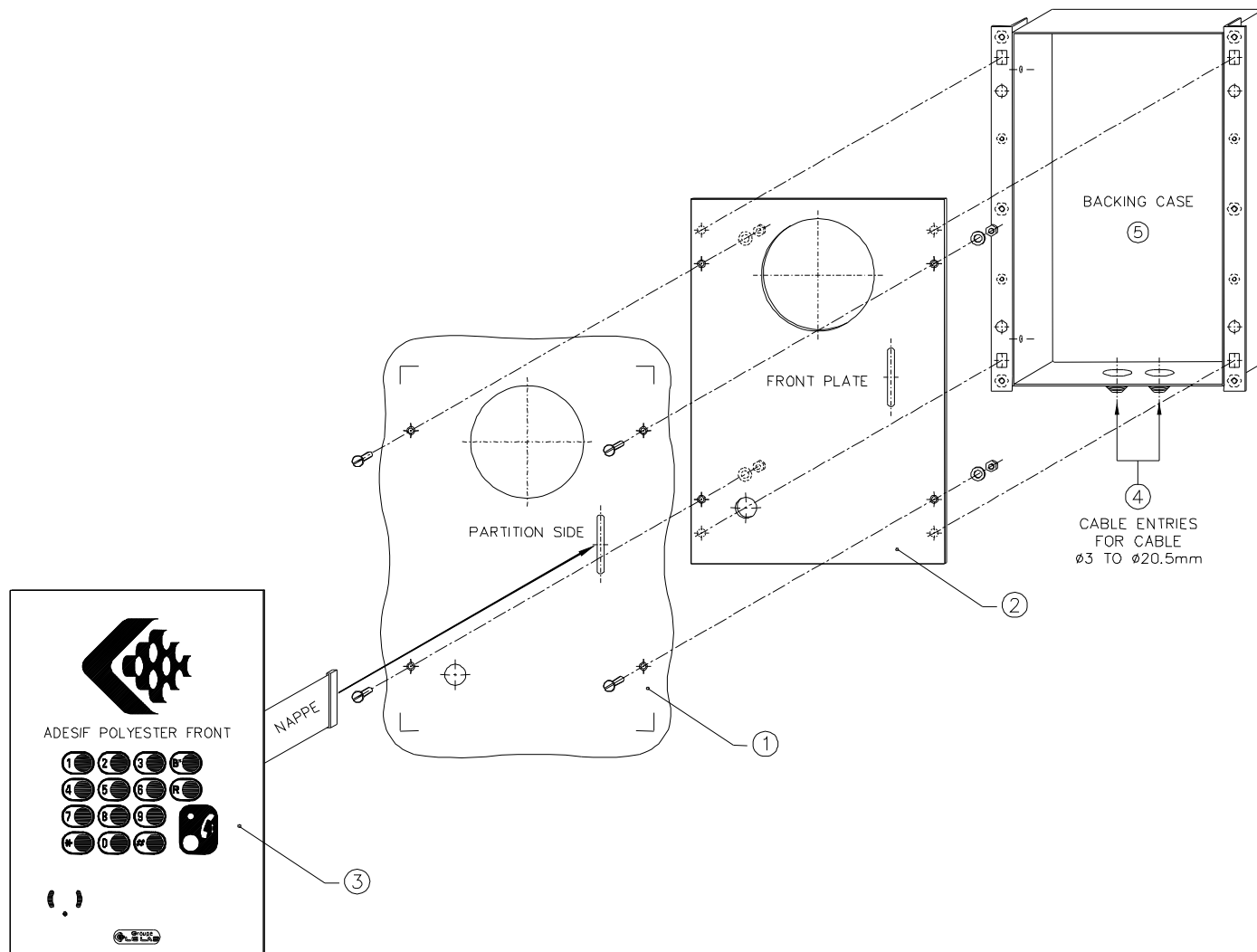

- 1 – Cut out the panel according to the values above
- 2 – Fasten the face-plate on to the panel using countersunk screws.
- 3 – Place the keypad ribbon cable in the face-plate slot, then fasten the plaque.
Connect the ribbon cable to connector « P4 » of the telephone card (see page 18)
- 4 - Pass the line cable through the cable-entry, leaving sufficient length for connection.
Connect the telephone line on to terminal BR1 of the telephone card (see page 19)
- 5 – Clip the backing-case on to the face-plate.

2.5 INSTALLATION OF TLS 250 S1 CLS

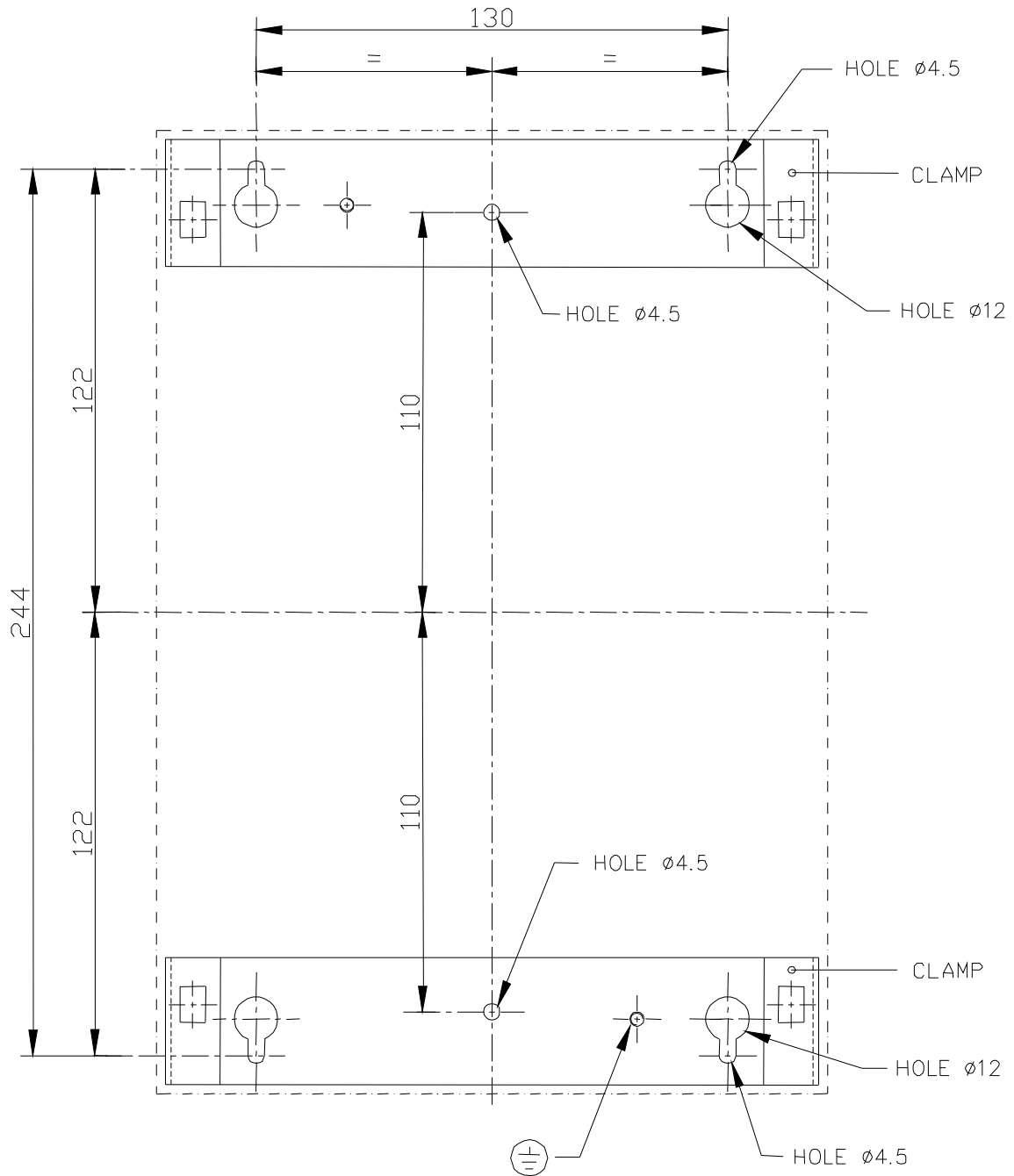

2.6 TLS 250 S1 CLS MOUNTING INSTRUCTIONS

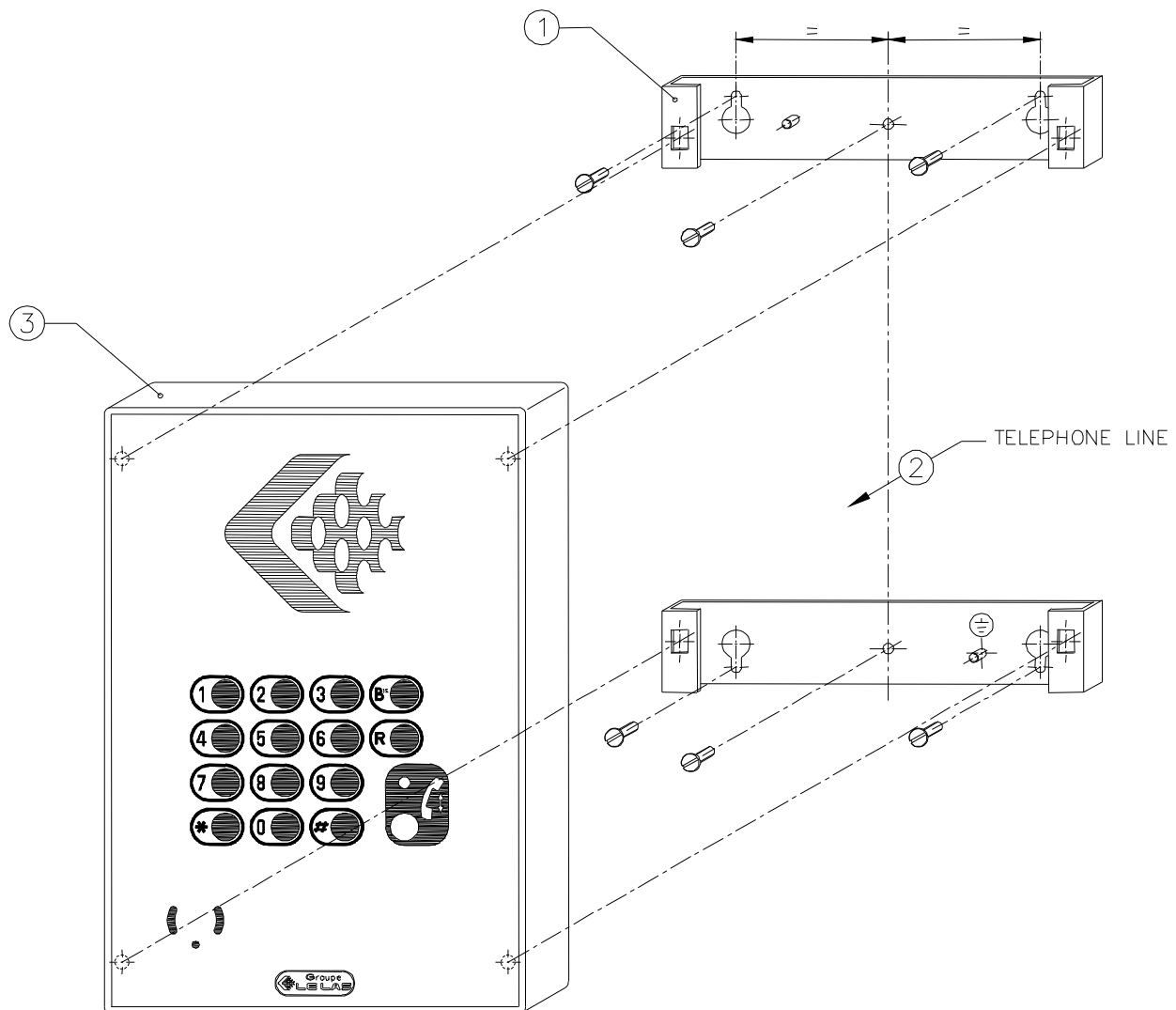

PROJECTING ASSEMBLY



- 1 - To carry out the layout by respecting the dimensions given page 16, then to fix the clamps.
(not provided screws and bolts)
- 2 - To connect the telephone line on terminal "BR1" of the telephone chart (see page 19).
- 3 - Clipser the case on the clamps and to produce a seal bead around the case with joint silicone.

NFC250S*TEL1/UK

3. LAYOUT OF THE TELEPHONE CARD

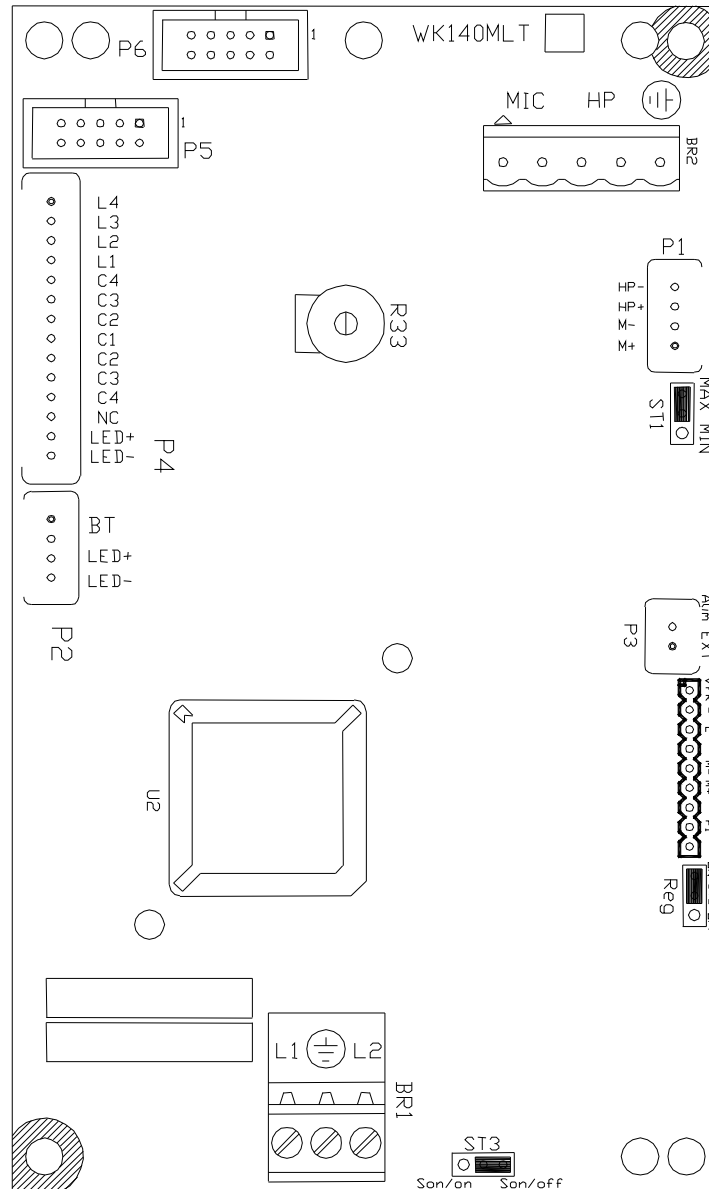
3.1 FUNCTIONS AND JUMPER SETTINGS



FUNCTIONS	REPAIRS	JUMPERS
SENSITIVITY OF THE HANDS FREE MICROPHONE Sensitivity up to 1m Sensitivity up to 30cm	ST1	MIN  MAX MIN  MAX
RÉCEPTION LEVEL ADJUSTMENT Minimum setting : quiet location Maximum setting : noisy location NOTE : normal setting is carried out in factory (see drawing)	R33	MIN  MAX

4. CONNECTION OF THE TELEPHONE SET

4.1 OPENING THE TELEPHONE SET

For telephone type TLS 250 S1 CL :

To have access to the circuit of the station, to remove the joint silicone and unclip the front face of the case using a screwdriver. After reinstallation of the front face, not to forget to remake the sealing of the front face with joint silicone (see page 13).

For telephone type TLS 250 S1 CLD :

To have access to the circuit of the station, unclip the case postpones using a screwdriver.

For telephone type TLS 250 S1 CLS :

To have access to the circuit of the station, to remove the joint silicone and unclip the case using a screwdriver.

After reinstallation, not to forget to remake the sealing around the case with joint silicone.

4.2 CONNECTION OF THE TELEPHONE LINE

The connection of the unit to the telephone line is carried out on printed circuit board WK140MLT with the plug-in connector reference « BR1 ».

Connect the telephone line to the terminals L1 and L2 of the connector « BR1 ».

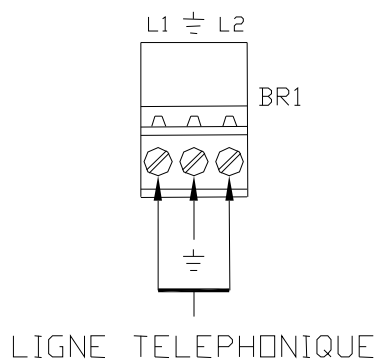

EARTHING THE TELEPHONE SET

Electrical earthing is carried out either externally via the earthing screw (situated at the bottom of the case) indicated by the sign \perp or internally on the terminal \perp situated on the « BR1 » connector on the telephone card WK140 MLT.

As gas discharge tube is located on the card, to discharge possible overloads to earth.

5. USAGE OF THE TELEPHONE WITH FULL KEYPAD

HOW TO MAKE A CALL

1
PRESS THE CALL BUTTON



The red indicator shows

When the called party answers, speak in front of the telephone from a distance of
Approximately 20cm (8in).

At the end of conversation, to free the line :

3
PRESS THE CALL BUTTON
OR ALLOW THE TELEPHONE TO CLEAR DOWN
AUTOMATICALLY



The red indicator ceases to show.

HOW TO ANSWER A CALL

When the telephone rings

1
PRESS THE CALL BUTTON
OR ALLOW THE TELEPHONE TO CLEAR DOWN
AUTOMATICALLY



The red indicator shows

When the called party answers, speak in front of the telephone from a distance of
Approximately 20cm (8in).

At the end of conversation, to free the line :

2
PRESS THE CALL BUTTON
OR ALLOW THE TELEPHONE TO CLEAR DOWN
AUTOMATICALLY



The red indicator ceases to show

LAST NUMBER REDIAL

1
PRESS THE CALL BUTTON



The red indicator shows

2
PRESS **BIS/LR**



When the called party answers, speak in front of the telephone from a distance of
Approximately 20cm (8in).

At the end of conversation, to free the line :

3
PRESS THE CALL BUTTON
OR ALLOW THE TELEPHONE TO CLEAR DOWN
AUTOMATICALLY



The red indicator ceases to show.

FLASH RECALL

PRESS « R »



A programmed flash recall of 270ms takes place
Length of time of flash can be adjusted by programming

The **R** button has a three functions according to the programming : flashing or direct memory M1
(see chapter programming page 25) or muting microphone.

If « Direct Memory » is selected, the R button is used in the same way as the Call Button on the
« S1 » Autodial version.

NOTE

LENGTH OF CONVERSATION IS LIMITED IN THE FACTORY TO A
LIMIT OF 4 MINUTES.
IT CAN BE CHANGED BY PROGRAMMING.

MUTING MICROPHONE

In noisy environment, it may be useful to activate or deactivate the microphone by pushing a key. (« R » key is used)

For this facility, program the unit as following :

24xx = 0 Flashing time deactivated.

32xx = 99 going « on hook » by pressing a memory key a long time deactivated.

At the beginning of the communication, microphone is activated.

By pushing « R », microphone is still on.

By releasing « R », microphone is deactivated.

Microphone is then activated by « R » key as a « PTT » key (push to talk) till the end of the communication.

6. OPTIONS

6.1 RELAY BOARD – DOOR ENTRY / PUBLIC ADDRESS (WK026CRG)

This optional card connected via a flat ribbon cable to telephone card WK140MLT, enables the activation of a relay from a remote telephone or system. This relay can activate for example:

- electric door entry mechanism
- lighting
- public address amplifier with loudspeaker

In its factory setting, the code to activate the relay is 1. This code must ALWAYS be keyed between two * characters. Keying * 1 * from a remote telephone will therefore activate the relay. Wherever a double relay card (WK026CR2G) is used, the second relay is activated by code *2*, by adding 1 to the first relay code value.

Keying this code on the keypad of a telephone equipped with a relay board will not activate its own relay.

In the factory setting, the activation time of the relay is 2 sec. The DTMF code * is used to deactivate the relay. The activation code (up to 4 digits) and the time (value between 00 and 99 seconds) are modifiable (see programming page 25).

NOTE

IF THE ACTIVATION TIME IS 00 THE TIMING IS NOT ACTIVATED.
TO DE-ACTIVATE THE RELAY SIMPLY PRESS *
IN ALL CASES THE RELAY WILL BE DE-ACTIVATED ON HANGING UP.

- Relay contact capacity: 60 Volts, 1 Amp
- ST1, ST2 setting jumper:
 - T relay closed when activated
 - R relay open when activated

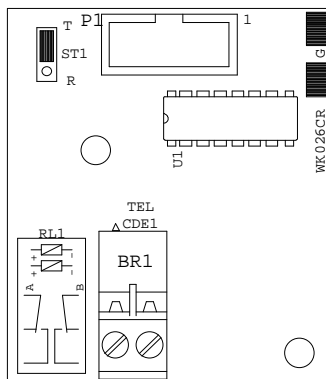

WK026CRG : 1 relay board

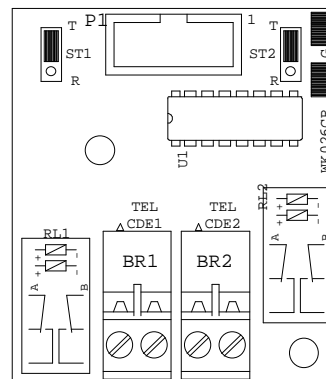

WK026CR2G : 2 relays board

6.2 AMPLIFIER CARD WK087CRA

All variants can be equipped with this booster card which amplifies reception by 10-20 dBA subject to current available and the balance of the loudspeaker compared with the microphone. Can be fed by the line or a 1.5VA external source.

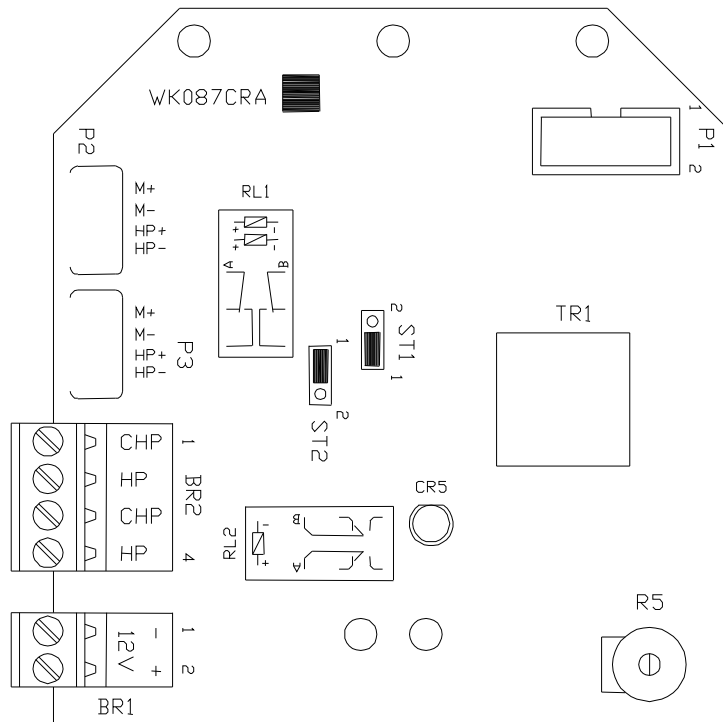

Several applications are possible:

- 1/ Remotely fed by the telephone line and internal loudspeaker (minimum current 40mA). Voice is amplified by approx. 10Db.
- 2/ External 12VDC power supply and internal loudspeaker. Voice is amplified by approx. 20 Db. If 12V power supply is removed, case 1 applies.

In case 1 and 2 jumpers ST1 and ST2 are in position 1 and ringing is not amplified.

- 3/ External 12 VDC power supply and external loudspeaker. Voice and ringer are then amplified by approx. 20 Db. Jumper ST1 is in position 1 and ST2 IN POSITION 2. The external loudspeaker must be connected to 1 and 2 on BR2. If the 12VDC power supply disappears the telephone functions with its extension loudspeaker amplified by the line current.

Potentiometer R5 facilitates volume adjustment in the 3 cases within the limit of distortion and feedback.

Connection of the external 12VDC voltage on +/-3 on terminal BR1.

7. PROGRAMMING

The TLS telephone is designed to facilitate programming remotely over a telephone line.

Programming is carried out using sequences keyed from a DTMF telephone, when connected to the TLS telephone to be programmed.

CAUTION :

1- When entering programming, do not re-key for a second time the access code, if you are not sure that you have heard the acknowledgement beep, because in doing so you run the risk of modifying parameters relating to the first two digits of the code.

Enter code *6000* if you hear the unit's ID (one or more beeps according to the identifier), this means that you were in programming mode and you can therefore proceed to program your options. If you don't hear a beep, enter the programming access code to re-enter programming.

2- Telephones connected via digital lines may not enter programming mode satisfactorily..

7.1 PROGRAMMING CODES

IMPORTANT :

Before all programming, key the access code : *1234* (factory setting) or as changed by the user (see function 12/13 below).

The acceptance sequence is a single beep if memory M0 (see function 18 below) is empty or a single beep followed by the contents of Memory 0 followed by « * » if memory M0 has been programmed.

Non-acceptance is indicated by « no-response » in which case it is necessary to try again.

Proceed with programming as follows :

For each programming sequence below the telephone gives an acceptance/non-acceptance sequence. The acceptance sequence is a mix DTMF tones (functions N° 1, 5 and 18 below) or a single beep (all other functions).

In all cases the non-acceptance sequence is two beeps.

If the non-acceptance sequence is received, it is necessary to try again.

Function No	Function	Programming code
1	<p><u>AUTODIAL NUMBERS</u> (If no chaining is required) If chaining is required, use function No5 instead (page 24)</p> <p>During memory programming , the combination #11# Represents the recognition of a continuous tone with a frequency of 440 Hz ± 100Hz (standard) before dialling.</p> <p>This is the standard for UK and many other countries but in Some other countries #10# may be applicable instead, Whereby a 2-second pause is inserted rather than tone recognition.</p> <p><u>PROCEED AS FOLLOWS :</u> SINGLE BUTTON TELEPHONE Program button : N = autodial number from 1 to 15 digits.</p> <p>Program empty memory : (factory preset)</p> <p>DUAL-BUTTON TELEPHONE Program lower button : N = autodial number from 1 to 15 digits.</p> <p>Program empty memory :</p> <p>Program upper button : N= autodial number from 1 to 15 digits.</p> <p>Program empty memory : (factory preset)</p> <p>For 4 - BUTTON TELEPHONE program memories 1, 3, 5, 7 with autodial numbers and memories 2, 4, 6 and 8 as empty memories.</p> <p>For 8 – BUTTON TELEPHONE Program memories 1 – 8 with autodial numbers and set chaining times T1 and T2 (see function 5 below) to 00 seconds. For full keypad telephone, to assign button R (recall) to Memory 1</p>	<p>*5001*#11#N*</p> <p>*5002**</p> <p>*5001*#11#N*</p> <p>*5002**</p> <p>*5005*#11#N*</p> <p>*5006**</p> <p>For 8-button telephone ONLY. *2000* and *2100*</p> <p>*2400*</p>
2	<p>TYPE OF DIALLING / CONFIGURATION Although this equipment can use either loop disc or DTMF</p>	

	<p>Signalling only the performance of the DTMF signalling is subject to regulatory requirements for correct operation. It is therefore strongly recommended that the equipment is set up to use DTMF signalling for access to public or private emergency services.</p> <p>DTMF signalling also provides faster call set-up.</p> <p>For configuration, each function has a value as follows:</p> <p>1/ DTMF dialling and automatic clear-down. 00</p> <p>2/ For pulse dialling and automatic clear-down. 01</p> <p>3/ No access to memory dialling : 02</p> <p>4/ No clear-down on receipt of tone : 04</p> <p>5/ Push to talk mode : 08</p> <p>Those values should be summed and the total applies e.g :</p>	<p>*1000*</p> <p>*1001*</p> <p>*1007* = pulse dialling, no access to memory dialling, no clear-down on receipt of tone.</p>
3	<p>LOUDSPEAKER VOLUME</p> <p>V= volume from 1 to 9 (factory setting = 5)</p>	*140V*
4	<p>RINGING VOLUME</p> <p>V= volume from 1 to 7 (factory setting = 7)</p>	*160V*
5	<p>PROGRAMME A NUMBER CHAIN</p> <p>It is possible to program a number chain, so that, for autodial buttons, if the first number dialled is busy or does not answer, the telephone will dial one or more alternative number in a 'chain' until successful connection is made. All telephone numbers programmed into the chain must be different, no number may appear more than once. (see note in function 1 above for usage of #11# and #10#)</p>	<p>*500M*#11#N*</p> <p>M (memory) = 1,2,...8 max.</p> <p>N= Call number up to 15 digits</p> <p>The chain stops at the first empty memory.</p>

	<p><u>THE STEPS TO TAKE ARE :</u></p> <p>SINGLE-BUTTON TELEPHONE Program the main number in memory 1 and additional Numbers in memories 2-8. Program an empty memory following the last number entered, e.g., if two numbers are programmed, memory 3 should be empty : (factory preset)</p> <p>DUAL-BUTTON TELEPHONE Program lower button with memory 1 and either one or two Additional memories (as required) for chaining, e.g., for two additional numbers, program memory 1 with the main Number and memories 2 and 3 for back-up numbers.</p> <p>Program the next memory, in the example shown memory 4, as an empty memory :</p> <p>Memory 5 is designated as the main number for the upper Button. This is programmed in the same way as memory 1. Finally, memories 6, 7 and 8 are programmed with additional numbers for the upper button.</p> <p>NB : No chaining is possible with the 4-BUTTON or 8-BUTTON telephone.</p> <p>To program the interval between memory auto-dial attempts T1 between M1 – M2 and T2 between M2 – M3, M3 – M4 etc... if necessary</p> <p>These times are the intervals in the event of no-answer Before dialling the next number.</p> <p>For T1 key : TT is the time in seconds. If only one number TT=00</p> <p>For T2 key :</p>	<p>*5003**</p> <p>*5004**</p> <p>*20TT*</p> <p>*21TT*</p>
--	--	---

	<p>If chaining 2 or several numbers, 2 choices are possible :</p> <p>a) to hear what actually happens on the line : program T1/T2 with even number (e.g., :30 sec)</p> <p>b) to mask what happens on the line (no-answer, busy tone,...) until the called party picks up, by simulating ringing and flashing LED. On detection of speech from the called party, a long beep announces to both parties that the communication has been established, the LED shows constant. For this, program T1/T2 with an odd number (e.g. 31 sec.)</p>	
6	<p>NUMBER OF RINGS BEFORE AUTOMATIC ANSWER</p> <p>In the factory, the telephone is set to answer automatically after 3 rings. To change this number, key :</p> <p>NN= 00 to 99 NN= 03 factory setting (answer automatically after 3 ring or manually by pushing the button) NN= 00 automatic answer with no ringing (suitabel only for programming) NN= 99 No automatic answer (answer only manually by pushing the button)</p> <p><u>Important note :</u> Where 00 is programmed, both microphone and loudspeaker are de-activated on auto-answer, where 01-98 is programmed, the microphone is de-activated on auto answer (but the loudspeaker is active). The microphone can be activated by pushing any button. If, in this case, the telephone receives programming signals (from an operator or call-centre system, the loudspeaker is de-activated. It can be re-activated by keying the code * 9901 *</p>	*11NN*

<p>7</p>	<p>RELAY ACTIVATION TIME This should be set to There is no limit to the relay activation duration. The relay is de-activated by pressing the * key or by hanging up.</p> <p>DD= 01 to 98 DD= 00 (no limit) Factory setting 02 (sec.)</p> <p>ACTIVATION CODE In the factory, the relay activation is set to 1.</p> <p style="text-align: center;">NOTE</p> <p>The code can be between 1 to 9999 If this code has 4 digits, it must not be the same value as the programming access code.</p> <p>The remote command code is a 4 digit code. To program it, 2 actions are required : Programming of thousands and hundreds, identified below as T and H Programming of tens and units, identified below as D and U</p> <p>For T and H, key :</p> <p>TH = 00 to 99 If T = 0 it is a 3 digit code If TH = 00 It is a 2 digit code</p> <p>For D and U, key : DU = 00 to 99 If THD = 000 It is a 1 digit code</p>	<p>*25DD*</p> <p>*26TH*</p> <p>*27DU*</p>
<p>8</p>	<p>MAXIMUM CALL DURATION Length of conversation before automatic cleardown</p> <p>Range XX=-00 No limit XX=-99 99 minutes Factory setting 4 minutes.</p>	<p>*12XX*</p>

9	<p>DURATION OF SILENCE BEFORE AUTOMATIC CLEARDOWN</p> <p>XX = 30 30 seconds (factory setting) XX = 00 Does not clear down on duration of silence XX = 99 99 seconds Note : frequency tones are taken as silence.</p>	*13XX*
10	<p>TYPE OF RINGING MODULATION</p> <p>XX = 00 Pure Frequency (factory setting) XX = 01 3 Frequencies mixed</p>	*15XX*
11	<p>DURATION FOR WHICH BUTTON MUST BE PRESSED CONTINUOUSLY BEFORE TELEPHONE GOES « ON LINE »</p> <p>XX = 00 Immediate (factory setting) XX = 99 9.9 seconds</p>	*17XX*
12	<p>PASS CODE (1) First two digits of programming pass-code</p> <p>XX = 12 (factory setting) XX = 10 (range) XX = 99</p>	*30XX*
13	<p>PASS CODE (2) Last two digit of programming pass-code Note : The pass-code is a 4 digit code (from 1000 – 9999). It is input in two halves, as described above.</p> <p>XX = 34 (factory setting) XX = 10 (range) XX = 99</p>	*31XX*
14	<p>DURATION FOR WHICH BUTTON MUST BE PRESSED CONTINUOUSLY FOR CLEARDOWN TO TAKE PLACE</p> <p>XX = 20 (factory setting) XX = 00 (range) no clear down XX = 99 9.9 seconds</p>	*32XX*

15	<p>MINIMUM TONE RECOGNATION/CLEARDOWN FREQUENCY</p> <p>XX = 25 250Hz (factory setting) XX = 00 0Hz (range) XX = 99 990Hz</p>	*34XX*
16	<p>MAXIMUM CLEARDOWN TONE FREQUENCY</p> <p>XX = 50 500Hz (factory setting) XX = 00 0Hz (range) XX = 99 990Hz</p>	*35XX*
17	<p>RETURN TELEPHONE TO FACTORY SETTING ERASE MEMORIES</p> <p>XX=00 Acknowledgement from telephone after about 1.3s XX = 02 Erase memories M0 – M9</p>	*98XX*
18	<p>PROGRAM TELEPHONE ID</p> <p>This is a code of up to four digits which should be programmed into memory M0. The telephone will automatically transmit this ID code followed by « star » (*) on receipt of the command code *0600* from a central system. N = telephone ID up to 4 digits</p>	*5000*N*

8. OPERATIONAL COMMAND CODES

Function No	Function	Programming code
1	<p>REQUEST TELEPHONE ID</p> <p>This code is transmitted by the central system to determine the identity of a telephone calling the centre. The telephone will respond with its telephone ID (see programming code 18 above)</p>	*0600*
2	<p>AUTOMATIC CLEARDOWN</p> <p>At the end of a call without access to programming, the central system or operator can effect an automatic clear-down by transmitting this code :</p> <p>However, if the call has included access to programming, automatic clear-down is carried out by transmitting this code :</p>	<p>*0990*</p> <p>*9900*</p>
3	<p>TEST MICROPHONE AND LOUDSPEAKER</p> <p>Acknowledgement from telephone : 1 sec. Transmission of frequency of 1244Hz Followed by : 1sec. Transmission of frequency of 622Hz Note : After test, the loudspeaker is switched off.</p> <p>To re-activate the loudspeaker :</p> <p>To conclude the test :</p>	<p>*9700*</p> <p>*9901*</p> <p>*9900*</p>

9. MAINTENANCE

TLS telephones require little maintenance to remain in excellent operational condition. Carry out the following maintenance if necessary.

EXTERNALLY

Clean using a dampened soft cloth.

Utilisation possible de fongicide, bactéricide et virucide conventionnel.

La face avant polyester résiste aux solvants, sauf aux produits chimiques suivants :

Acides minéraux concentrés, solution caustique concentrée,
vapeur haute pression à plus de 100°C, benzyl alcool, chlorure de méthylène.

10. IN THE EVENT OF A PROBLEM

Before consulting the maintenance service, we advise you to check the following points:

PROBLÈM WITH LINE CONNECTION OR DIALLING

- Check telephone line connection on the connection terminal (see page 19)

TRANSMISSION PROBLEM

- Check the setting of jumper ST1 (see page 18)

RÉCEPTION PROBLEM

- If transmission is weak, adjust the reception to the level required (see page 18).

11. SPARE PARTS LIST

- | | |
|-----------------------------|------------|
| • Telephone board | WK 140 MLT |
| • 50 Ohms - 5 W Loudspeaker | CE 124 V11 |
| • Electret microphone | CE 515 V2 |
| • Adhesif polyester front | 250 S 100 |

NOTES

GROUPE LE LAS - PARIS

FRANCE

34/36 RUE ROGER SALENGRO
F 94134 FONTENAY SOUS BOIS

Tel : 33 01 48 76 62 62

Fax : 33 01 48 76 83 04

Internet : www.lelas.fr

E-mail : lelas@wanadoo.fr

BELGIQUE

BD BRACOPS 205/1
B. 1070 BRUXELLES

Tel : 00 32 25 22 83 66

Fax : 00 32 25 27 83 14

E-mail : lelas@skynet.be

UNITED KINGDOM

SAFE COMMUNICATIONS LTD
BANK HOUSE - SOUTHWICK SQUARE
SOUTHWICK

U.K BRIGHTON W. SUSSEX BN 42 4 FN

Tel : 00 44 12 73 87 14 00

Fax : 00 44 12 73 59 66 00

E-mail : sales@safecommunications.net

ITALY

TELEINDUSTRIA SRL
VIA PALERMO, 12
I. 20090 ASSAGO (MI)

Tel : 00 39 02 45 71 37 29

Fax : 00 39 02 45 71 40 00

Internet : www.teleindustria.com

E-mail : sales@teleindustria.it

Edition J : 02.04.2007